

**EN**  
English

# Manual of electronic humidifier



**DE**  
Deutsch

**FR**  
Français

**ES**  
Español

**IT**  
Italiano



# Table of Contents

- 1 **Parts of humidifier**
- 2 **Connecting humidifier**
- 3 **Filling humidifier**
- 4 **Adjusting humidity level**

## We care about quality in cigars

Thank you for purchasing this product. Please read this manual in its entirety to fully enjoy the benefits and features of this product. Please keep this manual for future reference.

Note: A clear film is applied to the display that must be removed prior to using this product. Locate the clear tab and simply peel to remove.

**Accuracy:** The sensors of the microprocessor control unit of the humidifier continuously measure the ambient level of humidity. Once the humidity falls under the preset value the ventilation system is activated which blows air through the water cartridge into the humidor, until the preset value has been reached. The current humidity level is shown at the display of the digital hygrometer.

**Air circulation:** The periodic air circulation via the quiet ventilation system ensures more even climate conditions inside the humidor than any passive humidification system.

**Low Maintenance:** The humidifier lasts longer with one refill than most other electronic humidification devices on the market. Each refill will last several months in a desktop humidor. The AC operation guarantees that no periodic battery replacements are required as in other battery operated systems on the market. No periodic purchase of specific humidification liquids is required anymore, as the humidifier is filled simply with distilled water.

**Easy to use:** Simply fill and plug in the humidifier and it will automatically start to maintain a humidity level of 70% which is generally considered best for the storage of your cigars. According to your personal preferences you may change the preset value simply with the click of a button to any desired humidity level from 40-80%.

**Universal:** The humidifier can be used in basically all cabinet humidors on the market. No holes need to be drilled or other modifications of the humidor are required. A paper-thin flat power cable will simply be placed under the lid of the humidor.

You have purchased one the most advanced new generation electronic humidification systems on the market. From now on you enjoy always fresh and perfectly conditioned cigars. You will not have to worry anymore about checking continuously the humidity level in your humidor. Spend your time enjoying a good smoke instead of having to perform monthly refilling procedures of your humidifier. One refill will ensure now several months of constant no-worry conditioning of your humidor.

## 1 Parts of humidifier

- 1. Digital LCD control hygrometer
- 2. Air ventilation/Fan
- 3. Knob to open humidifier
- 4. Air vent
- 5. Humidity Sensor
- 6. External fan terminal (sold separately)

- 7. Power input terminal (for flat cable)
- 8. Water cartridge

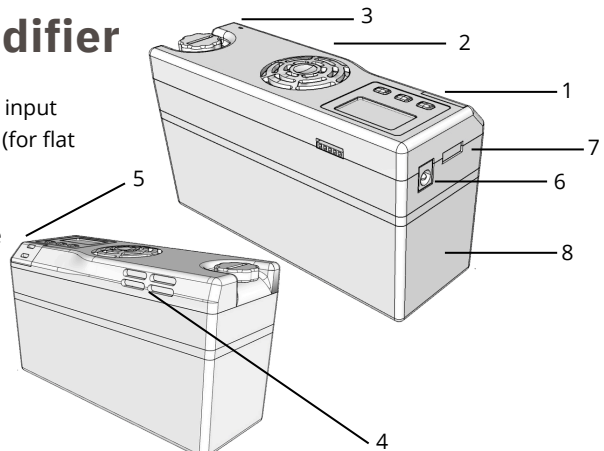

## 2 Connecting humidifier

Unpack the case remove all the poly bags and packing material as shown below:



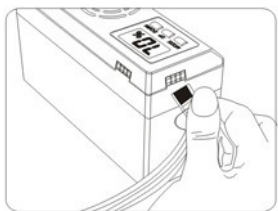

1) Use the DC flat cable to connect the main connection port of the humidifier.



2) You can choose among different electrical outlets according to your preference.

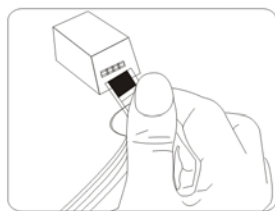

3) Connect the other end of the DC flat cable to the DC converter port.

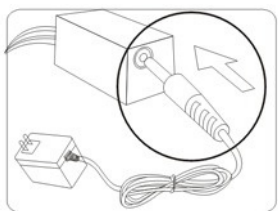

4) Connect the sub-port of the transformer to the DC converter port.

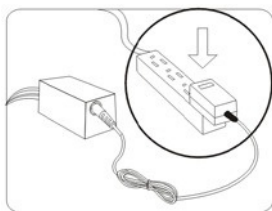

5) When everything is connected, plug into electrical source.

Please make sure that you are using the included flat power cable and not directly plugging the round power adapter into the top control unit. The flat power cable connects to the DC 12V terminal (#7). Do not connect the round power plug into the "EXT FAN" terminal (#6).

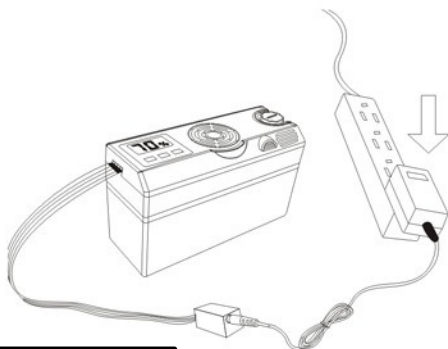

**Warning:** If improperly connected, the fan may continue to run even after reaching the target humidity.

### 3 Filling humidifier

- 1 Use hand or coin to unscrew knob on the humidifier. Separate knob from the base, open the humidifier, and expose the water cartridge. Please refer to picture 1. Ensure that rubber rings stay in original position. Keep the middle silicon cap on for humidors under 300 cigars and take the cap off for humidors over 300 cigars to boost the moisture.

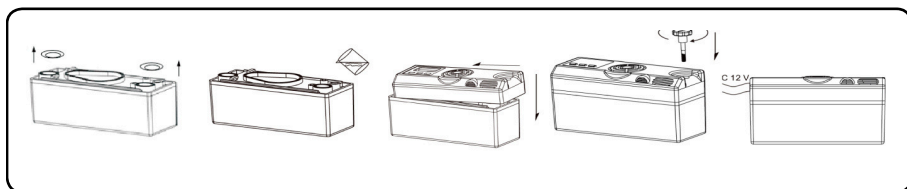

- 2 Fill distilled water into the water cartridge (8) as in picture 2, until the crystals inside are completely saturated. Wipe any excess water from around the cartridge.

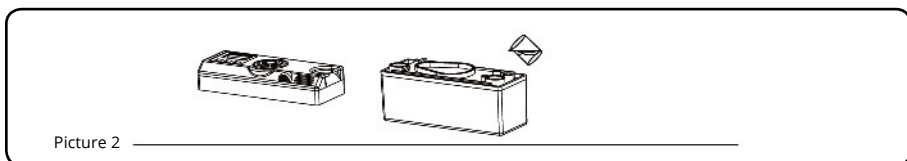

Picture 2 \_\_\_\_\_

- 3 Close the humidifier by screwing the knob. (Attention: make sure the 3 rubber rings (11) are lined properly). Insert the flat power extension cord into an electrical outlet (6 or 7) and plug the power transformer into the wall. The humidifier should now be working.

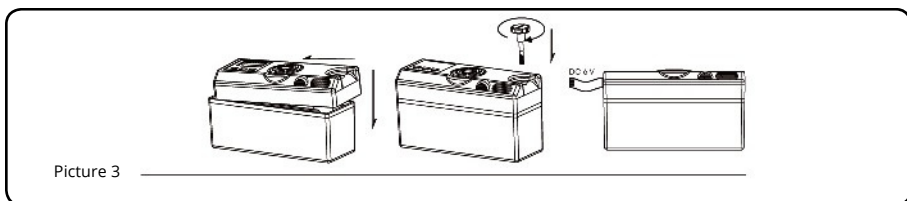

Picture 3 \_\_\_\_\_

- 4** Please note that in a new humididor it may take some time, up to a few days depending on its size, until the wood has absorbed sufficient humidity thus reaching the desired humidity level.

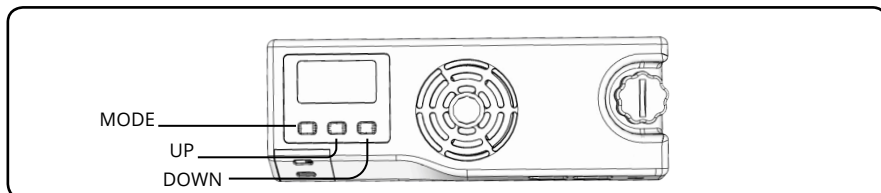

- 5** This humidifier, once filled, lasts longer than most other humidifiers for desktop humidors on the market. Depending on the size of the humididor and the frequency with which you open it, one refill may last up to 3-6 months. Once the water cartridge is empty, or when the humidity starts dropping below 2% of the pre-set humidity level, you should refill the humidifier. Always use distilled water when refilling. In a new humididor the first refill may last less than future refills.

- The water cartridge should be replaced after about 18-24 months of use.
- 6** Over time the absorption capacity of the sponge may reduce. Generally, with all humidification systems, it is highly recommended to replace the sponge/polymers of any humidifier periodically in order to prevent the creation of bacteria. You will not need to replace the whole humidifier, but only the water cartridge, which can be purchased at a low price at many tobacco stores.

## 4 Adjusting humidity level

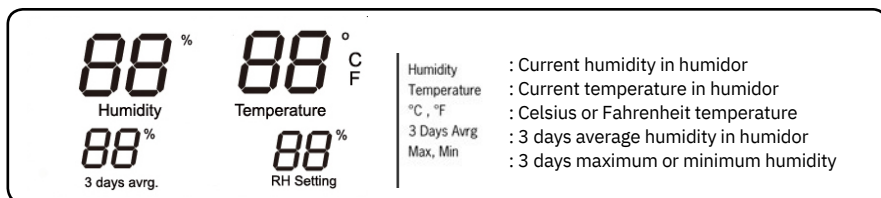

The humidity level is set at 70% by the manufacturer. However you can adjust this value based on your preference:

- 1** Press and hold **"MODE"** button for 3 seconds on the control panel. Numbers will start to blink on the display. Press the **"UP"** or **"DOWN"** button to raise or lower the humidity level respectively.

- 
- 2** The fan will turn on automatically once the humidity level drops more than 1% below its pre-set value. The fan will turn off automatically when the humidity level is 1% higher than its pre-set value (e.g. if the pre-set humidity level is 70% but the actual humidity is 71%) and the fan will remain inactive until the actual humidity drops more than 1% below its pre-set value once again.
  - 3** Pressing the **"MODE"** button quickly will switch from Celsius to Fahrenheit.
  - 4** Pressing the **"UP"** and **"DOWN"** buttons quickly will display the Max/Min humidity.

The indication of the indoor temperature is just for information. The humidifier will control the humidity, but will not control the temperature in your humidifier.

---

## Specifications

Factory pre-set Humidity target	Humidifier Accuracy	Measures Humidity Reading	Manually Adjust Range
70%	+/-1%	40%-80%, +/-3%	40%-80%

Operating current	Wall Outlet Power	Humidifier Power import	Size(L*W*H)
600mA	100-240V/AC	12V/DC	22,9cm*12,0cm*11,5cm

## Re-calibrating the hygrometer

Each humidifier is equipped with a capacitive humidity sensor, the same used in commercial laboratories. Most digital hygrometers available are equipped with resistive sensors which can have a RH variance of +/- 10%. Please make sure the hygrometer used to match humidity has a capacitive sensor.

To calibrate the humidifier, hold the 'MODE' button (keep holding it) and before the numbers flash in the bottom right corner, immediately adjust the meter with the 'UP' and 'DOWN' buttons. The numbers on the upper left side of the humidifier will increase or decrease depending on what you need. Use this function to match the humidifier to the other hygrometer that you are trying to match it to.

